

BKD 150

Bayonet cable duct

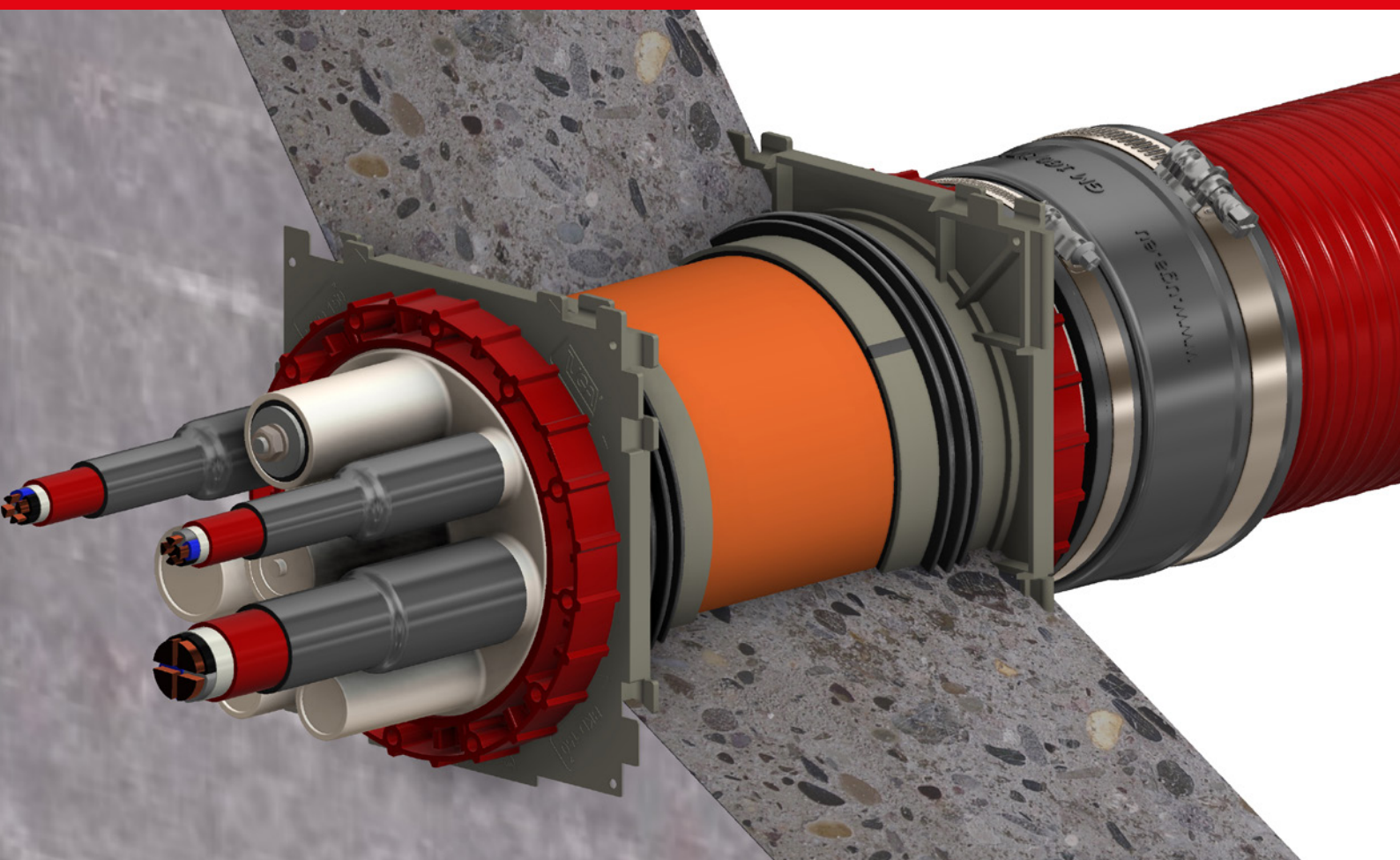

**24 hour delivery
service**
upon request

**Quality
guarantee**
on all products



**Worldwide sales
network**
for you locally

Service hotline
Tel. +49 7324 9696-33
We are happy to help you

Sealing cables in no time

The BKD 150 system from UGA

Service hotline

Tel. +49 7324 9696-33

We are happy to help you

► Quick installation thanks to bayonet lock

The bayonet mount of the BKD 150 system enables the quick connection of system covers or cable protection pipes to the flange sleeve. And a reliable seal is already guaranteed. Sealing cables doesn't get any easier.

Thermal shrink sleeves TM are supplied with the system covers as standard. Optionally, KS cold shrink sleeves are available.



System cover



Flange sleeve



BKD 150 system

► The benefits of the BKD 150 system

- Fast, simple assembly
- Immediately gas and water pressure-tight
- Perfect, reliable sealing
- Suitable for hot and cold shrink technology
- Lots of variants and connection options
- Variable assembly in batteries
- Special version for double/element walls available
- Fire protection S90 can be retrofitted according to DIN 4102-9

► One system for all cases

The BKD 150 system always offers the right variant for the changing requirements on construction sites. Single, double, angular and flange sleeves are available as well as various system covers, cable protection systems KSS and connection sleeves.

► Processing instructions

The flange sleeve is fastened with pin nails and encased flush in concrete in the casing. Nail holes are provided in the flange sleeve for fastening. In order to prevent honeycombing, the flange sleeve must be completely encased in concrete. In the case of single flange sleeves, the direction of installation must be determined before concreting. The flange sleeves are suitable for waterproof concrete stress class 1 and 2.

The UGA collar technology makes it possible to connect all types of pipes and hoses to the BKD 150 system. Subsequent sealing is also possible with the UGA BKD 150 system inserts with integrated protection against misalignment.



System cover



Cable protection system KSS



BKD 150 bayonet system insert with misalignment protection

BKD 150

Bayonet flange sleeves

► Immediately tight and protected

We manufacture our flange sleeves in length to match the wall thickness. Each flange sleeve comes with a gas- and water pressure-tight system cover as a blind cover. For single flange sleeves, a dirt cover is also included on the back (non-connection side). This keeps the interior clean during installation, and the flange sleeve is immediately gas- and water pressure-tight after encasing in concrete.

► Permanent connection to concrete

The flange sleeve is equipped with a sealing system. This guarantees absolute tightness to the concrete.

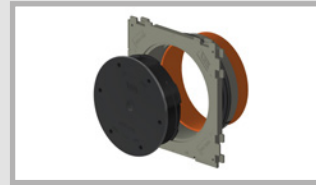

Single flange sleeve
Suitable for one-sided connection of a system cover or KSS system; Can be used from 50 mm wall thickness; The direction of installation must be specified!
Product name:
BKD150-K/(L)

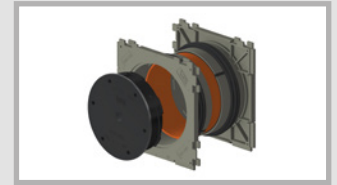

Double flange sleeve
Suitable for connecting a system cover or KSS system on both sides; Can be used from 100 mm wall thickness
Product name:
BKD150-K2/(L)
Special version for double/element walls available
Product name:
BKD150-K2-EW/(L)
(L) = Wall thickness in mm

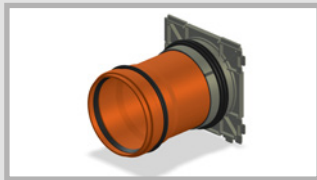

Single flange sleeve with pipe connection sleeve
Suitable for one-sided connection of a system cover or KSS system; opposite side to the direct connection of a smooth-walled cable protection pipe with 110, 125 or 160 mm outside diameter;
Minimum wall thickness 200 mm
Product name:
BKD150-K-SM110/(L)
BKD150-K-SM125/(L)
BKD150-K-SM160/(L)

Also available as single flange sleeve with pipe connection sleeve in collar technology
Product name:
BKD150-K-MA125/(L)
BKD150-K-MA145/(L)
BKD150-K-MA170/(L)
(L) = Wall thickness in mm
Clamping range:
125 = 110 mm - 125 mm
145 = 130 mm - 145 mm
170 = 160 mm - 170 mm

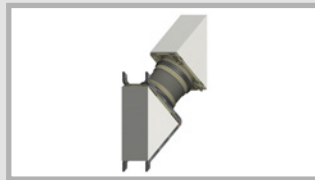

Angular flange sleeve
Suitable for cables fitted at angles of 30°, 45° or 60°;
With auxiliary frame and styrofoam wedge;
Single or double flange sleeve also available in a battery assembly;
Minimum wall thickness 250 mm

Angular single flange sleeve:
Product name:
BKD150-K-S30/(L)
BKD150-K-S45/(L)
BKD150-K-S60/(L)

Angular double flange sleeve:
Product name:
BKD150-K2-S30/(L)
BKD150-K2-S45/(L)
BKD150-K2-S60/(L)

(L) = Wall thickness in mm



Stainless steel double flange sleeve
Suitable for sealing in accordance with DIN 18533 (fixed/loose flange design for black trough); Double-sided connection of a system cover or KSS system possible; Also available assembled in a battery (flange plate);
Minimum wall thickness 100 mm

Product name:
BKD150-K2-F+L-W2/(L)/V2A
Pressurised water
Flange diameter fixed flange 525 mm

Product name:
BKD150-K2-F+L-W1/(L)/V2A
Non-pressurised water
Flange diameter fixed flange 325 mm
(L) = Wall thickness in mm
Also available as stainless steel single flange sleeve Minimum wall thickness 50 mm

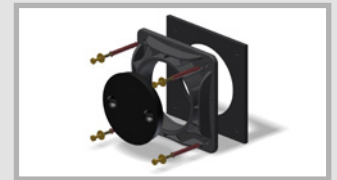

Assembly flange BKD 150-AF 235
Suitable for sealing of a core bore in a wall or ceiling
; Supplied with flange gasket, sealing ring, protective cover and fastening elements, optionally in galvanized steel or A4 stainless steel.
Suitable for one-sided connection of a system cover or KSS system; core bore diameter maximum 150 mm;
Flange size 235 x 235 mm

Product name:
BKD150-AF-235/BE-VZ
with steel fastening elements, galvanized

Product name:
BKD150-AF-235/BE-A4
with fastening elements made from A4 stainless steel

Product index for BKD 150 bayonet flange sleeves (examples)

Bayonet single flange sleeve

BKD150-K/(L)

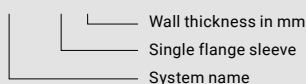

Bayonet double flange sleeve

BKD150-K2/(L)

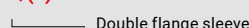

Bayonet double flange sleeve assembled in a battery 2 x 3

BKD150-K2/2x3/(L)

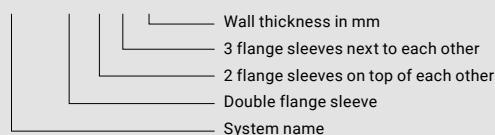

45° angular flange sleeve as a double flange sleeve

BKD150-K2-S45/(L)

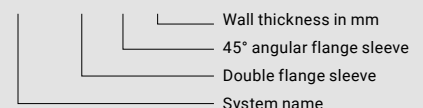

Bayonet double flange sleeve for double/element walls

BKD150-K2-EW/(L)

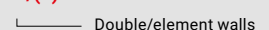

BKD 150 bayonet system cover and other connection options

► One connection, lots of possibilities

A system cover with connection piece or sleeve as well as a KSS cable protection system can be connected to the BKD 150 flange sleeve. For subsequent sealing of fitted cables, we recommend the BKD 150 system insert with protection against possible misalignment.

► Handling

System cover and KSS cable protection systems are assembled before the cables are fitted using the articulated spanner. Unoccupied system cover connection pieces can be sealed with sealing plugs VS and are thus available for retrofitting.

► Cold or hot shrink technology

In the standard version, we supply system covers with thermal shrink sleeves TM. Optionally, cold shrink sleeves are available.

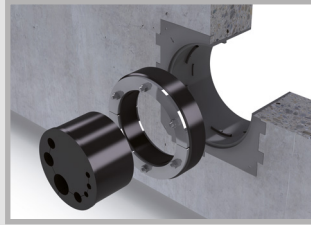

BKD 150 bayonet system insert
Split rubber press gasket with exchangeable insert use in BKD 150 flange sleeve; Suitable for retrofitting; Misalignment protection thanks to bayonet catch

Product name:
BKD150-E-WE/V2A/EPDM
(Z)x(D)
(Z)=Number of cables/pipes
(D)=Diameter of the cables/pipes

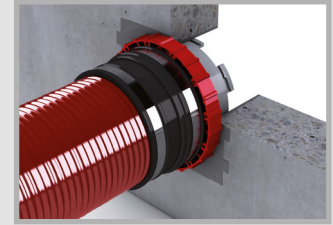

System cover with collar
Suitable for flexible connection of pipes or KSS cable protection systems to a flange sleeve; Compatible with all wiring protection systems; Main area of application: Connection of KSS systems

Product name:
BKD150-D-MA(D1)-(D2)

(D1) = Lower scope of application
(D2) = Upper scope of application

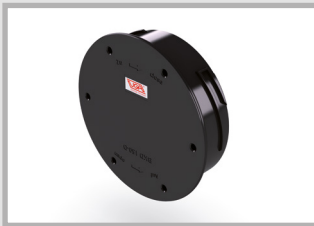

System cover closed
Blind cover for unoccupied flange sleeves;
This system cover is included in the scope of delivery of each flange sleeve.

Product name:
BKD150-D

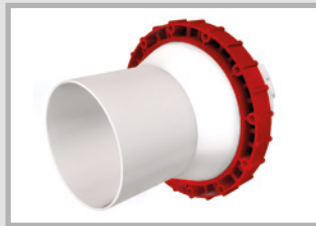

System cover with one connection piece and one thermal shrink sleeve TM
Version for a cable with a diameter of 34 – 108 mm

Product name:
BKD150-D-1/110-TM

Version for a cable with a diameter of 26 – 78 mm

Product name:
BKD150-D-1/80-TM

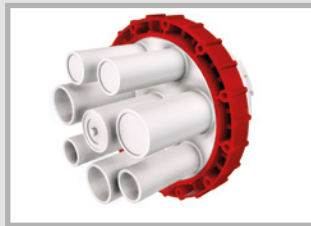

System cover with eight connection pieces and four thermal shrink sleeves TM
Four connection pieces are supplied closed, they can be opened if necessary; Suitable for max. four cables with a diameter of 7-23 mm and max. four cables with a diameter of 7-33 mm; Various AK spreader caps or VS25 or VS35 sealing plugs are available as accessories

Product name:
BKD150-D-8/35(4/2)/25(4/2)-TM

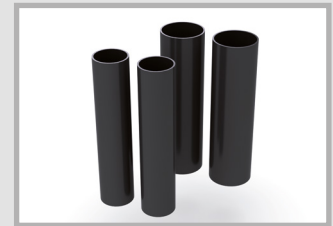

A special hot shrink sleeve set is available as an additional accessory for the retrofittable connection pieces.

Product name:
TM set D8/35/25



System cover with three connection pieces and three TM thermal shrink sleeves
Suitable for three cables with diameter 22 – 57 mm; Various AK spreader caps or VS 58/60 sealing plugs are available as accessories (New: VS 58/60)

Product name:
BKD150-D-3/59(3/3)-TM



System cover with seven connection pieces and six TM thermal shrink sleeves
One connection pieces is supplied closed, this can be opened if necessary; Suitable for max. seven cables with diameter 7–36 mm; Various AK spreader caps or VS38 sealing plugs are available as accessories.

Product name:
BKD150-D-7/38(7/6)-TM



System cover with collar
For connection of a cable protection pipe with outside diameter of 89, 110, 125, 160 or 170 mm; Intermediate sizes on request

Product name:
BKD150-D-MA75-89
BKD150-D-MA100-110
BKD150-D-MA115-125
BKD150-D-MA150-160
BKD150-D-MA160-170



Cable protection systems KSS
UGA cable protection hoses are available in four diameters with a wide range of connection elements; To connect to the BKD 150 flange sleeve, use the KSS B150 cable protection system. For more information, see the **KSS systems section**.

BKD 150 bayonet system inserts for retrofitting

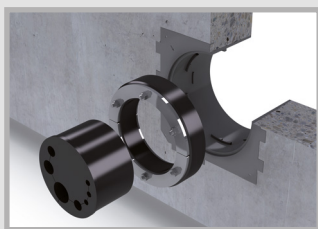

BKD 150 bayonet system insert with exchangeable insert

The bayonet system insert can be mounted regardless of the subsequent fitting. Depending on how the cable or pipe is fitted, a corresponding exchangeable insert is used. A change of fitting is possible at any time by replacing the exchangeable insert.

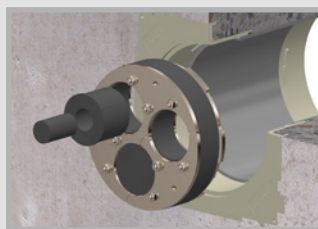

BKD 150 bayonet system insert with onion ring

With the bayonet system insert BKD150-E-ZS/V2A/EPDM 3x(22-54) up to three cables or pipes with diameters of 22 to 54 mm can be sealed safely. The onion rings can be infinitely adjusted to the cable diameters.

► The advantages of the BKD 150 system inserts

- Retrofitting in BKD 150 flange sleeves and in flange sleeves from other manufacturers
- Fast and simple assembly (without shrinking)
- Immediately gas and water pressure-tight
- Misalignment protection thanks to bayonet catch
- Lots of variants and sealing options
- Guaranteed tightness and safety thanks to the proven technology of the GPD rubber press gaskets
- Bending of process pipes up to 8° possible
- Absorption of axial movements
- Sound-insulating
- Protection against rodents

► High-quality materials

All metal parts are made of A2 stainless steel. Optionally, versions are available in A4 stainless steel. The rubber sealing elements are made of high-quality EPDM. On request, we also use NBR, EPDM approved for drinking water, silicone or FPM rubber.

► Function

By tightening the hexagonal nuts, the rubber washers are pressed together. The pressure creates a secure and permanent gas- and watertight seal.

Note: Bayonet system inserts must not be used as fixed points or bearings.



BKD 150 bayonet system insert with exchangeable insert

Split bayonet system insert with exchangeable insert for installation in BKD 150 flange sleeves (connection side)

Product name:

BKD150-E-WE/V2A/EPDM (Z)x(D)

Bayonet system insert BKD 150, with misalignment protection, split, EPDM rubber in 34 mm thickness, Ø 110 mm exchangeable insert in 60 mm thickness.

(Z) = Number of cables/pipes

(D) = Diameter of the cables/pipes

Maximum configuration:

Z = Number of cables/lines	D = Diameter of the cables/lines
0	Blind cover possible
1	up to 110 mm
3	up to 42 mm
5	up to 34 mm
7	up to 29 mm
9	up to 24 mm

Other configurations and combinations of various diameters are also possible

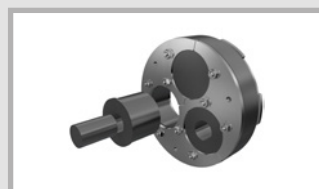

BKD 150 bayonet system insert with onion ring

Split bayonet system insert with onion ring for installation in BKD 150 flange sleeves (connection side)

Product name:

BKD150-E-ZS/V2A/EPDM 3x(22-54)

Bayonet system insert BKD 150, with misalignment protection, split, single-layer EPDM rubber, with three onion ring inserts for cables Ø 22-54 mm

For 0 to a maximum of 3 cables/pipes with diameters of 22-54 mm

Standard variants:

Product name:	Number of cables/pipes	Cable/pipe Ø mm
BKD150-E-ZS/V2A/EPDM 3x(22-54)	0-3	22-54
BKD150-E-ZS/V2A/EPDM 6x(4-32)	0-6	4-32
BKD150-E-ZS/V2A/EPDM 9x(4-20)	0-9	4-25
BKD150-E-ZS/V2A/EPDM 4x(4-32)+6x(4-20)	0-10	
	of which 0-4	4-20
	of which 0-6	4-20

Simply remove as many rubber elements as necessary until the desired diameter is reached. If you do not want to use a drilled hole or a flange sleeve, simply leave the rubber parts in the gasket. The system inserts with onion ring from UGA are suitable for universal use.

Accessories

Assembling in batteries



3-finger AK spreader caps
Hot shrink technology for sealing three cables in one system cover connection piece
Product name: **AK35/3F/2-12**
for system cover BKD150-D-8/35/25; Suitable for cables with an outside diameter of 2 - 11 mm
Product name: **AK50/3F/5-22**
for system cover BKD150-D-8/35/25 and BKD150-D-7/38; Suitable for cables with an outside diameter of 5 - 21 mm
Product name: **AK75/3F/8-29**
for system cover BKD150-D-3/59; Suitable for cables with an outside diameter of 8 - 28 mm



4-finger AK spreader caps
Hot shrink technology for sealing four cables in one system cover connection piece
Product name: **AK35/4F/2-13**
for system cover BKD150-D-8/35/25; Suitable for cables with an outside diameter of 2 - 12 mm
Product name: **AK50/4F/5-20**
for system cover BKD150-D-8/35/25 and BKD150-D-7/38; Suitable for cables with an outside diameter of 5 - 19 mm
Product name: **AK75/4F/8-29**
for system cover BKD150-D-3/59; Suitable for cables with an outside diameter of 8 - 28 mm



Sealing plug VS
For sealing unoccupied system cover connection pieces; Can be quickly removed for retrofitting or changing of cables;
Versions available for connection pieces with diameters of \varnothing 25, 35, 38, 59 mm
Product name:
VS25/VS35/VS38/VS58/60



Cold-shrink sleeve KS
For easy and fast assembly without aids, in all weather conditions; 2 bar gas and watertight; Available for all system covers



Articulated spanner GSS
For the assembly of all system covers and KSS systems;
With adjustable leg
Product name: **GSS**

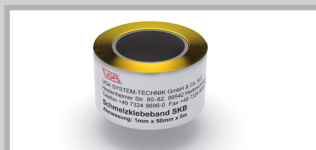

Melt-type adhesive tape SKB
Cold welding tape with very good adhesive properties for sealing and for corrosion protection; Ideal for wrapping around cables and pipes to enlarge the diameter for shrinking; Suitable for all plastics and metals
Thickness: 1 mm, width: 50 mm, roll length: 3.00 m
Product name: **SKB**



Cable cleaner KR
For environmentally friendly cleaning of cables of all kinds, even in the case of stubborn contamination; Odourless and residue-free evaporation; 500 ml spray bottle and 1,000 ml bottle
Density at 20°C: 0.764 g/cm³ Flash point: > 61°C
Evaporation number: 60
Identification: X_n
Product name: **KR/1-litre**



Torque screwdriver 5 Nm with fixed torque

► Variable assembling in batteries

Individual flange sleeves can be placed side by side and one above the other.

BKD150-K2/1x5/(L)

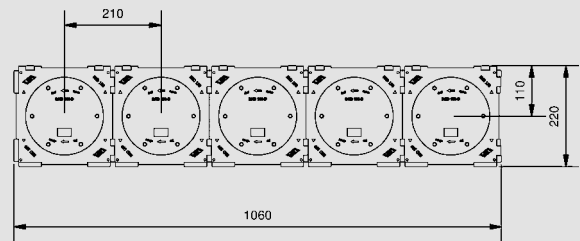

BKD150-K2/2x5/(L)

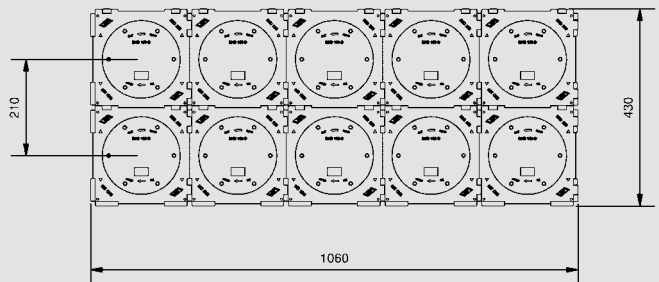

Angular flange sleeve

Sectional view, 45° angular double flange sleeve:

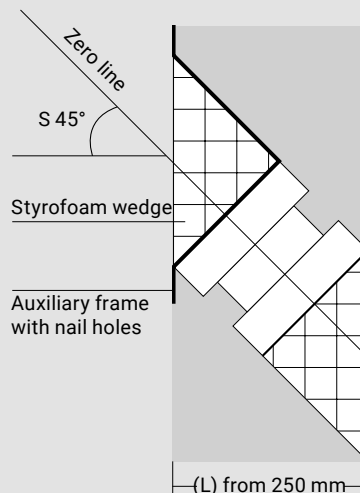

Tested tightness

The tightness of the bayonet cable duct BKD 150 was tested with a specially made test specimen consisting of a sealed concrete part and a test bell. Three system covers were used: the blind cover (BKD150-D), the system cover with a connection piece (BKD150-D-1/110) and the system cover with three connection pieces (BKD150-D-3/59).



During the helium test, the partial pressure of the helium in the air immediately after the test setup provided information about the leak rate of the system. During the destruction test, the pressure was increased until the cover collapsed.

► Tests conducted

- Gas tightness with air at an overpressure of 1 bar.
- Gas tightness with helium at an overpressure of 5 bar.
- Water pressure tightness at an overpressure of 5 bar.
- Destruction test

► Results

The results achieved far exceed the values required in practice.

• Gas tightness

The partial pressure (immediately after the test setup) was 5.4×10^{-6} mbar. This is a very good value, as the partial pressure of helium in the air is approx. 4.8×10^{-6} mbar.

• Water pressure resistance

There was no leakage of liquid.

• Destruction test

BKD150-D (blind cover)	5.00 bar
BKD150-D-1/80	>20 bar
BKD150-D-3/59	>20 bar

Service hotline

Tel. +49 7324 9696-33

We are happy to help you

UGA SYSTEM-TECHNIK GmbH & Co. KG
Heidenheimer Str. 80-82 • 89542 Herbrechtingen,
Germany
Tel. +49 7324 9696-0 • Fax +49 7324 9696-96
info@uga.eu • www.uga.eu

We shall supply replacements for all parts that impair functionality due to material defects. No replacements will be provided for defects that are due to transport or storage or are caused by incorrect processing or installation or consequences of such. Our information is based on current technical knowledge. Subject to technical changes. Because of the abundance of possible influences during assembly and use, our information does not exempt processors and users from their own trials and tests.

The corresponding installation instructions apply to all UGA products.